

Evaporation Technology

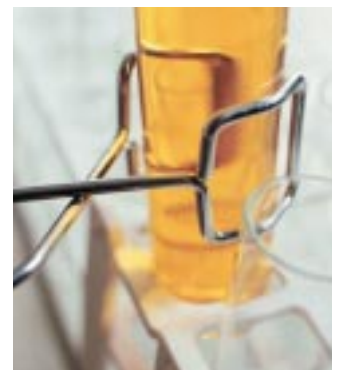

Evaporation Technology

Evaporation plants are used as a thermal separation technology, for the concentration or separation of liquid solutions, suspensions and emulsions.

A liquid concentrate that can still be pumped is generally the desired final product. Evaporation may however also aim at separating the volatile constituents, or distillate, as would be the case in a solvent separation system. During these processes, it is usual that product qualities are maintained and preserved.

These, together with many other requirements result in a wide variety of evaporator types, operating modes and arrangements.

GEA Wiegand has substantially contributed to the development of evaporation technology. The first Wiegand evaporator, built in 1908, was a patented multiple-effect circulation evaporator. This concentrated liquids in a gentle and efficient manner in a way unparalleled in its time. It was easy to control and had a compact arrangement.

Further technical developments led to the first Wiegand falling film evaporator, built in 1952, which combined these considerably improved, essential characteristics with new process possibilities, especially in the field of evaporating heat-sensitive products. At the same time, the thermal efficiency of evaporation plants was considerably improved.

Thanks to its advantages, the falling film evaporator has virtually replaced other evaporator types in many fields. Forced circulation and circulation evaporators still have some significance, whereas special types such as spiral tube, counterflow or stirrer evaporators are only used in special circumstances.

Research and Development



Due to ongoing research and development work spanning many decades, and the experience of several thousand installed references, GEA Wiegand continues to provide the broadest technical expertise and the respected ability to offer the best solution for almost any product, evaporation rate, operating condition or application.

GEA Wiegand has its own Research and Development Centre, where numerous laboratory and pilot plants are available for detailed analyses and testing in the field of evaporation and distillation. At the R&D Centre, important physical characteristics such as boiling point elevation, surface tension, solubility and maximum achievable concentration are determined. Certain pilot plants are available as mobile units and can therefore be installed at a customer's site. Data is captured and plant operating behaviour modelled by means of the latest computer programs.

The tests are performed in different types of tubular and plate evaporators and distillation columns. To date, more than 3,000 product categories have been tested through our plants. The alphabetical list of products tested ranges from acetone/alcohol mixtures to zinc dichloride.

Contents

Research and Development	2	Criteria for the Design Selection, Arrangement and	
Reference Products from GEA Wiegand Evaporation Plants	3	Operating Modes of Evaporation Plants	19
Evaporator Types	4	Evaporation Plant Components	19
Special Evaporator Types	11	Measuring and Control Equipment	22
Quantities and Concentration Ratios in Evaporation Plants	14	Manufacture, Transport, Erection, Commissioning	
Energy Efficiency of Evaporation Plants	15	and After-sales Service	23

Reference Products from GEA Wiegand Evaporation Plants

The following list shows groups of products that are successfully concentrated in more than 4.000 GEA Wiegand evaporation plants. Additional products are detailed in our reference lists.

Chemical and Pharmaceutical Industries

Caustic solutions	Caustic soda solution, caustic potash solution
Organic acids	Ascorbic acid, citric acid
Inorganic acids	Phosphoric acid, nitric acid
Saline solutions	Ammonium nitrate, ammonium sulphate, sodium sulphate
Amines	Urea, diethyl amine
Alcohol	Methanol, ethanol, glycerine, glycol, isopropanol
Organic products	Aromatic compounds, acetone, caprolactam water, synthetic glue, aromas
Pharmaceutical solutions	Enzymes, antibiotics, drug extracts, sugar substitutes, sorbitol, sorbose and gluconate
Suspensions	Kaolin, calcium carbonate
Waste water	Process waste water, wash and rinsing water, oil emulsions, etc.

Food and Beverage Industry

Dairy products	Whole and skimmed milk, condensed milk, whey and whey derivates, buttermilk proteins, lactose solutions, lactic acid
Protein solution	Soya whey, nutrient yeast and fodder yeast, whole egg
Fruit juices	Orange and other citrus juices, pomaceous juice, red berry juice, tropical fruit juices
Vegetable juices	Beetroot juice, tomato juice, carrot juice
Starch products	Glucose, dextrose, fructose, isomerase, maltose, starch syrup, dextrine
Sugar	Liquid sugar, white refined sugar, sweetwater, inulin
Extracts	Coffee and tea extracts, hop extract, malt extract, yeast extract, pectin, meat and bone extract
Hydrolisate	Whey hydrolisate, soup seasoning, protein hydrolisate
Beer	De-alcoholized beer, wort

Organic Natural Products Industry

Fermentation broth	Glutamate, lysine, betain
Glue and gelatine	Technical gelatine, edible gelatine, leather glue and bone glue
Emulsions	Miscella
Extracts	Tanning extract
Stillage	Whisky, corn, yeast, potato stillages, vinasses
Steep water	Corn steep water, sorghum steep water
Stick water	Slaughterhouse waste water, fish stick water, fruit peel press water, beet chips, fibre press water, fibreboard press water
Organic waste water	Wash water, wheat and potato starch effluents, manure
Blood	Whole blood, blood plasma



Evaporator Types

FALLING FILM EVAPORATORS

Design

Vertical shell-and-tube heat exchanger, with laterally or concentrically arranged centrifugal separator.

Operation

The liquid to be concentrated is supplied to the top of the heating tubes and distributed in such a way as to flow down the inside of the tube walls as a thin film. The liquid film starts to boil due to the external heating of the tubes and is partially evaporated as a result. The downward flow, caused initially by gravity, is enhanced by the parallel, downward flow of the vapour formed. Residual film liquid and vapour is separated in the lower part of the calandria and in the downstream centrifugal droplet separator. It is essential that the entire film heating surface, especially in the lower regions, be evenly and sufficiently wetted with liquid. Where this is not the case, dry spots will result

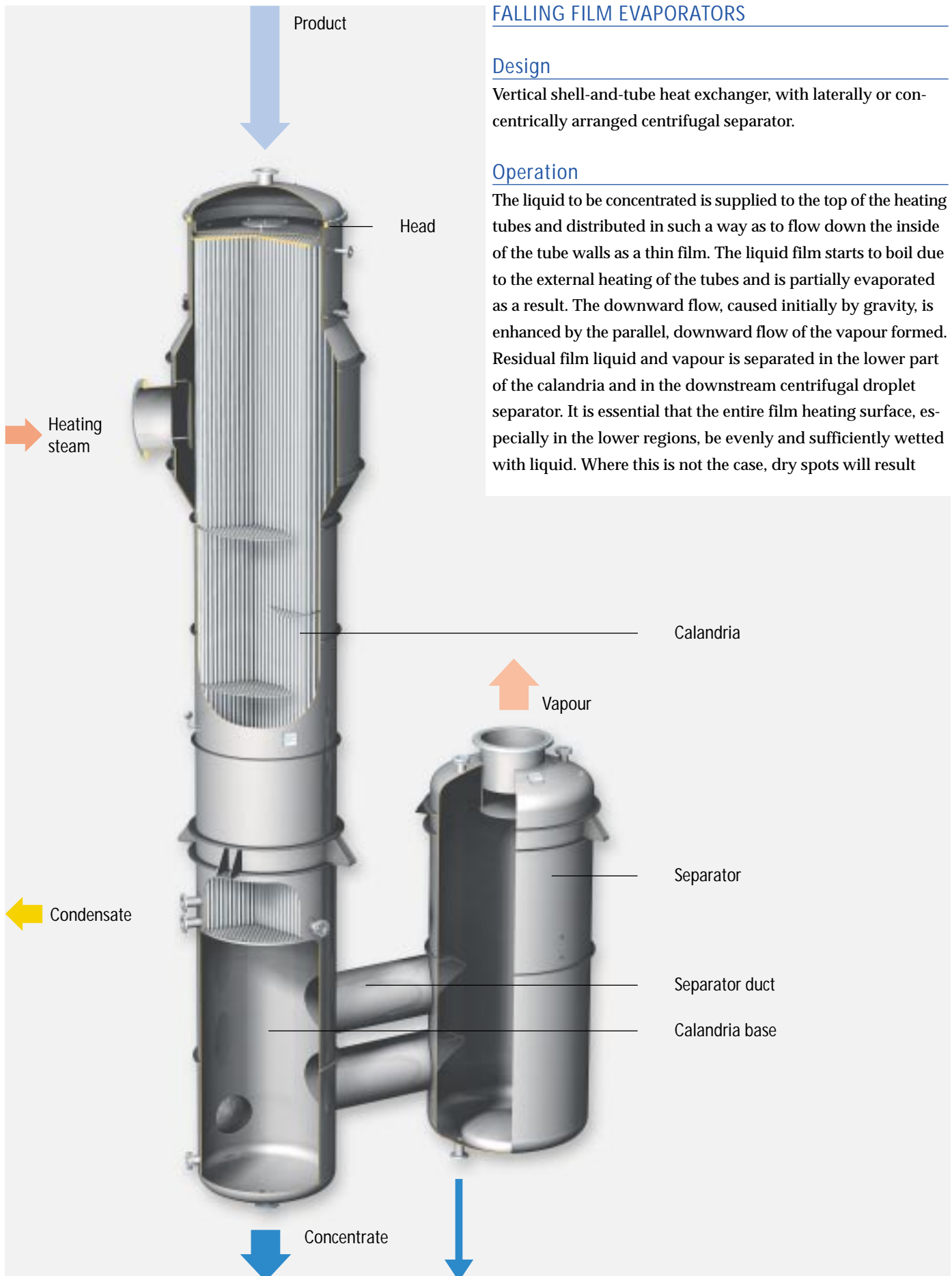



Two examples of suitable distribution systems, above: Perforated bowl, below: Tubelet

that will lead to incrustation and the build-up of deposits. For complete wetting it is important that a suitable distribution system is selected for the head of the evaporator.

Wetting rates are increased by using longer heating tubes, dividing the evaporator into several compartments or by recirculating the product.

Particular features

- **Best product quality** – due to gentle evaporation, mostly under vacuum, and extremely short residence times in the evaporator.
- **High energy efficiency** – due to multiple-effect arrangement or heating by thermal or mechanical vapour recompressor, based upon the lowest theoretical temperature difference.
- **Simple process control and automation** – due to their small liquid content falling film evaporators react quickly to changes in energy supply, vacuum, feed quantities, concentrations, etc. This is an important prerequisite for a uniform final concentrate.
- **Flexible operation** – quick start-up and easy switchover from operation to cleaning, uncomplicated changes of product.

Fields of application

- Capacity ranges of up to 150 t/hr, relatively small floor space requirement.
- Particularly suited for temperature-sensitive products.
- For liquids which contain small quantities of solids and have a low to moderate tendency to form incrustations.

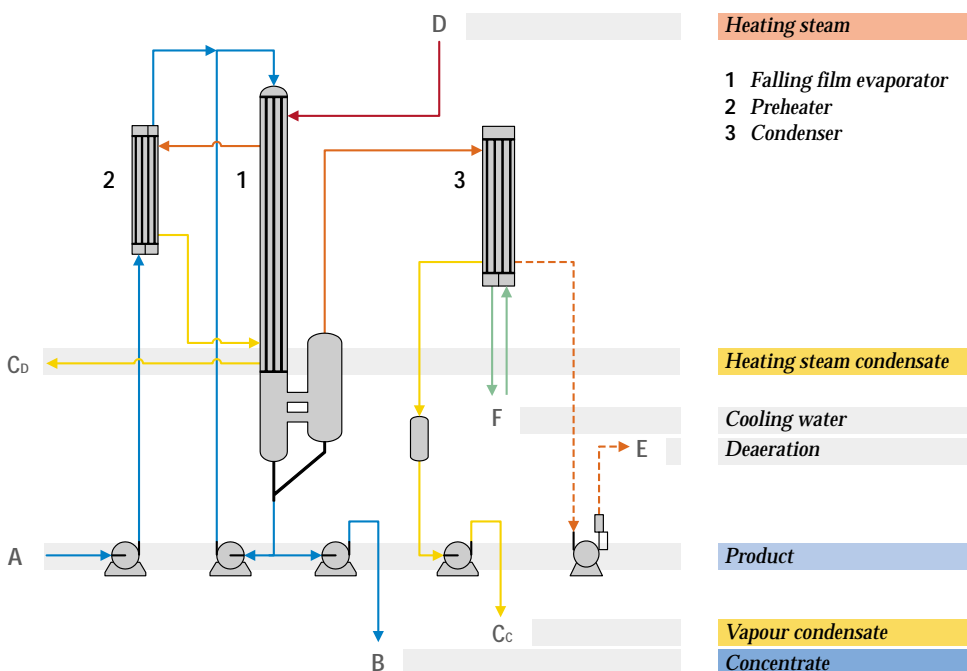

Evaporator Types

FORCED CIRCULATION EVAPORATORS

Design

Horizontal or vertical shell-and-tube heat exchanger or plate heat exchanger as the calandria, with flash vessel/separator arranged above the calandria, circulation pump.

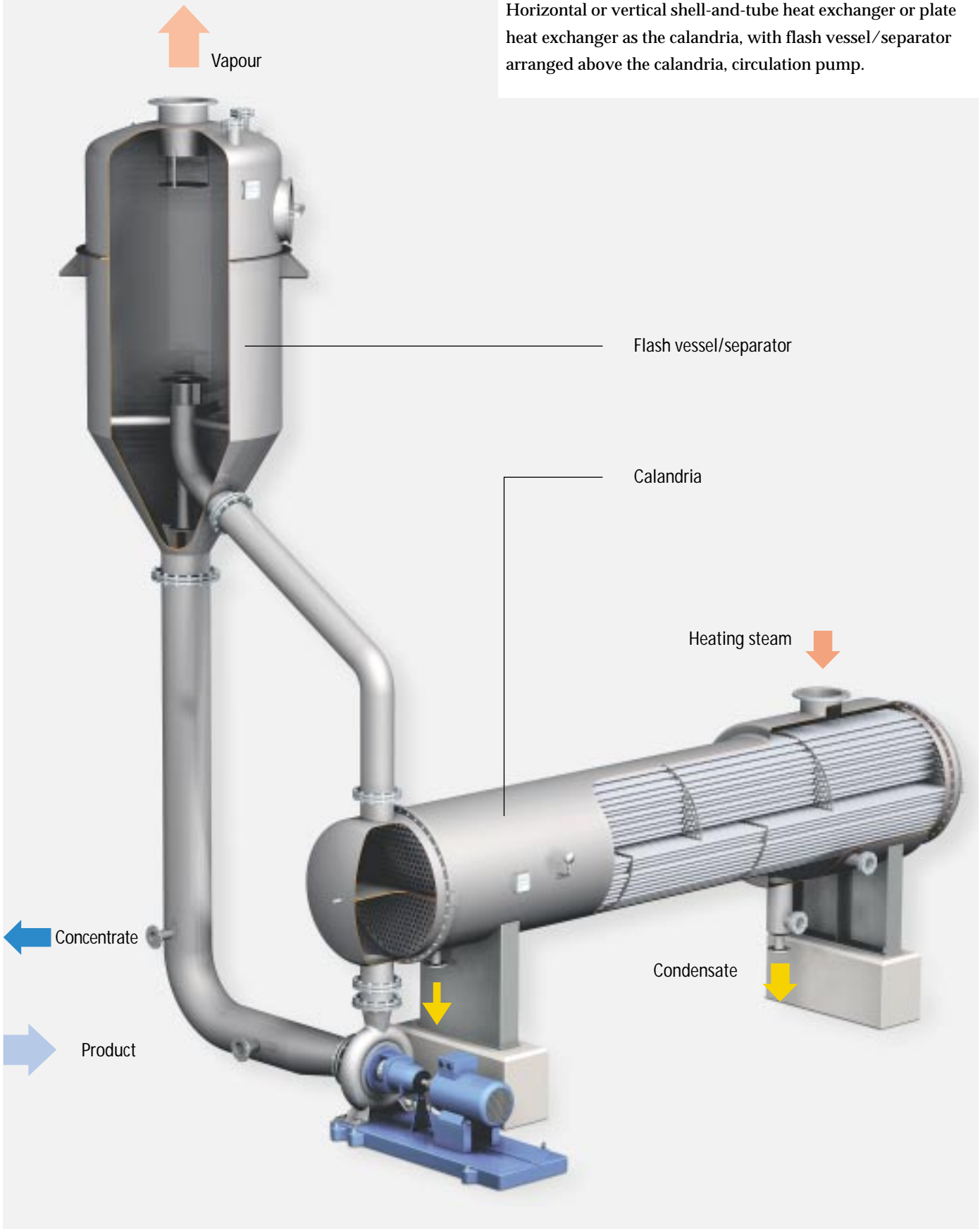

Operation

The liquid is circulated through the calandria by means of a circulation pump, where it is superheated at an elevated pressure, higher than its normal boiling pressure. Upon entering the separator, the pressure in the liquid is rapidly reduced resulting in some of the liquid being flashed, or rapidly boiled off. Since liquid circulation is maintained, the flow velocity in the tubes and the liquid temperature can be controlled to suit the product requirements independently of the pre-selected temperature difference.

Particular features

- **Long operating periods** – boiling/evaporation does not take place on the heating surfaces, but in the separator. Fouling due to incrustation and precipitation in the calandria is therefore minimised.
- **Optimised heat exchange surface** – flow velocity in the tubes determined by the circulation pump.

Fields of application

- Liquids with a high tendency for fouling, highly viscous liquids, as the high concentration step in multiple-effect evaporation plants.
- Forced circulation evaporators are optimally suited as crystallising evaporators for saline solutions.



2-effect falling film, forced circulation evaporation plant in counterflow arrangement with downstream system for the purification of vapour condensate by distillation of waste water containing salts and organic compounds. Evaporation rate: 9,000 kg/hr concentrated to 65 % TS

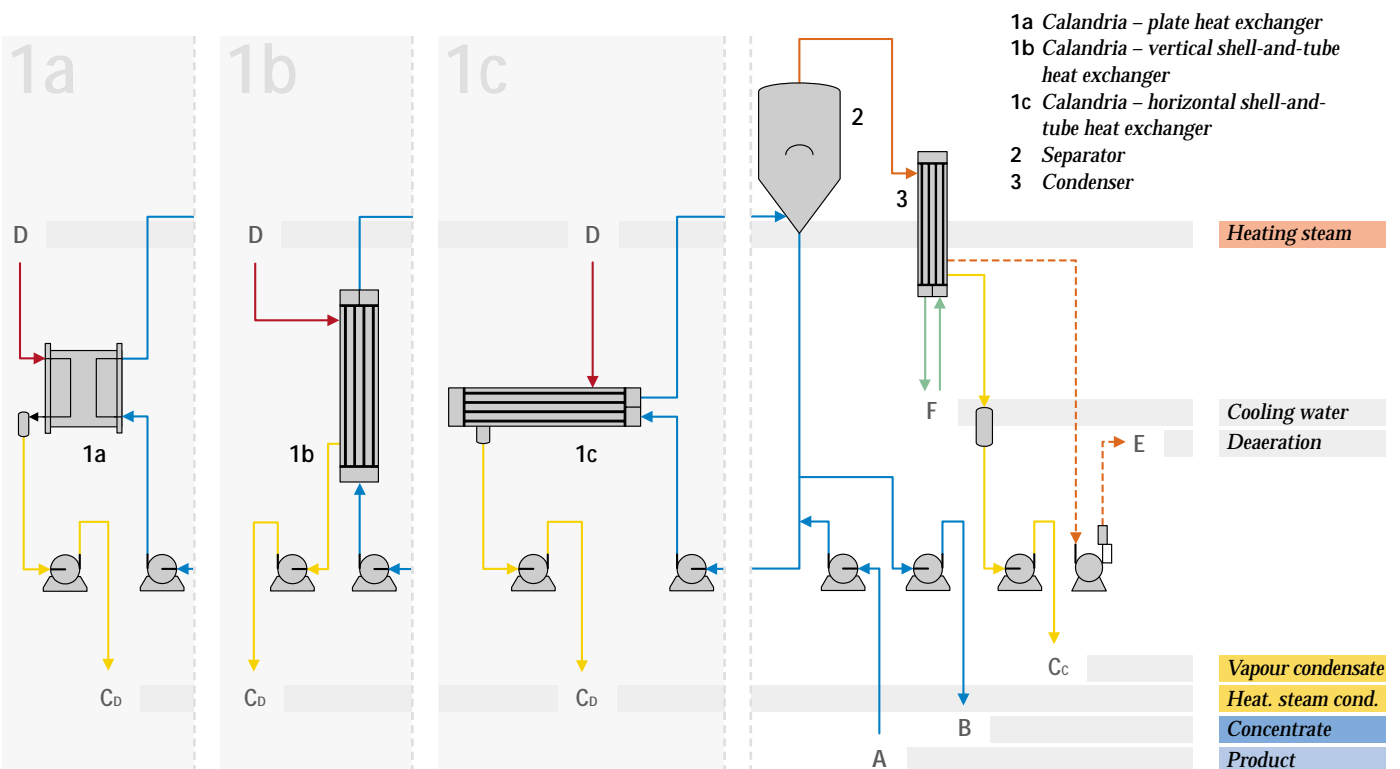

Evaporator Types

PLATE EVAPORATORS

Design

Plate heat exchanger, separator.

A plate-and-frame configuration employs special plates, with alternate product and heating channels. The plates are sealed by gaskets located within specially designed slots that do not require adhesives. These gaskets can be inserted and removed without special tools.

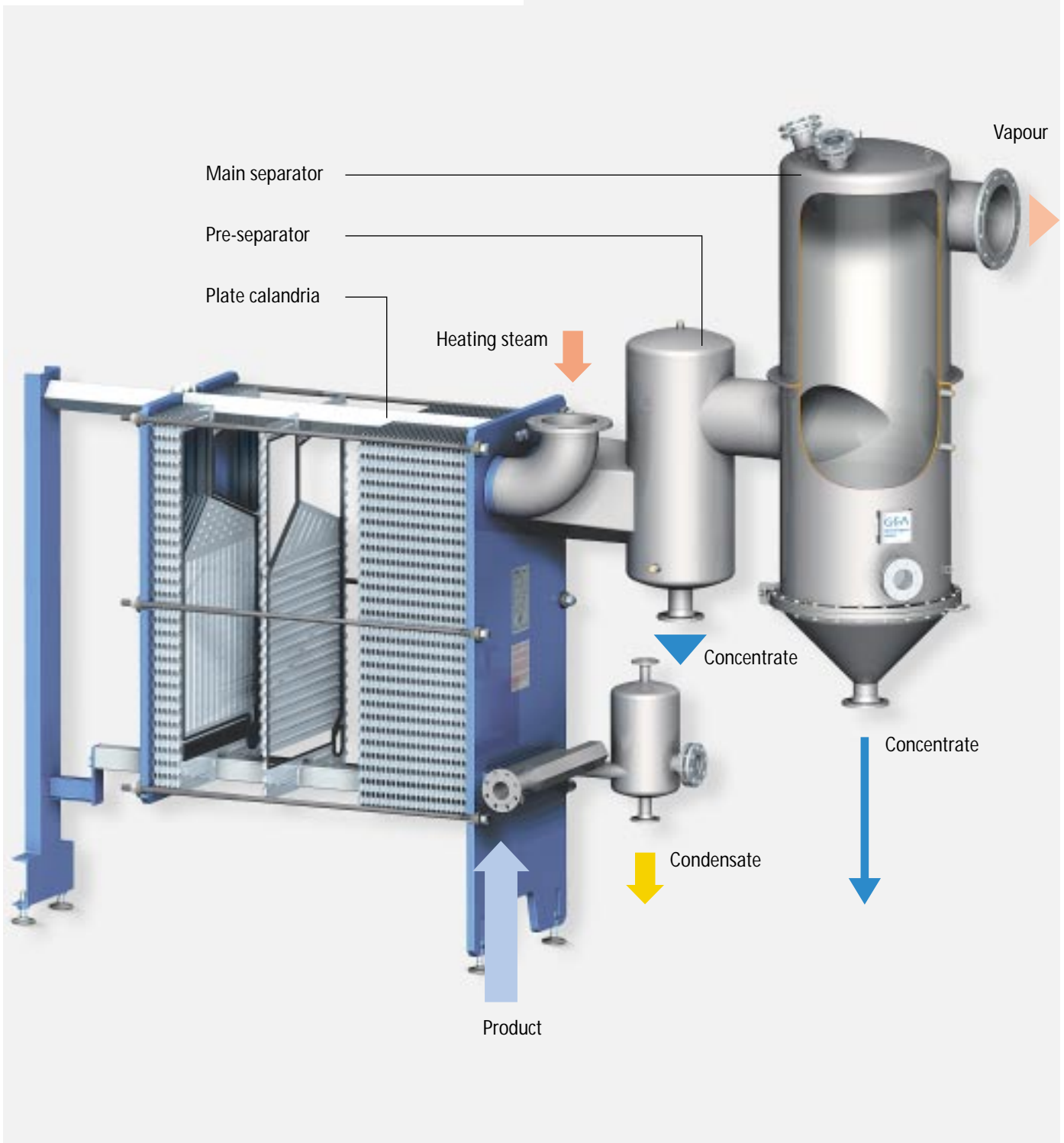

Operation

Product and heating media are transferred in counterflow through their relevant passages. Defined plate distances in conjunction with special plate shapes generate strong turbulence, resulting in optimum heat transfer.

Intensive heat transfer causes the product to boil while the vapour formed drives the residual liquid, as a rising film, into the vapour duct of the plate package. Residual liquid and vapours are separated in the downstream centrifugal separator. The wide inlet duct and the upward movement ensure optimum distribution over the total cross-section of the heat exchanger.



Particular features

- **Use of different heating media** – due to plate geometries, the system can be heated with both hot water as well as with steam.
- **High product quality** – due to especially gentle and uniform evaporation during single-pass operation.
- **Little space required** – due to compact design, short connecting lines and small overall height of max. 3 - 4 m.
- **Easy installation requiring little time** – due to pre-assembled, transportable construction units.
- **Flexible evaporation rates** – by adding or removing plates.
- **Ease of maintenance and cleaning** – as plate packages can be easily opened.

Fields of application

- For low to medium evaporation rates.
- For liquids containing only small amounts of undissolved solids and with no tendency to fouling.
- For temperature-sensitive products, for highly viscous products or extreme evaporation conditions, a product circulation design is chosen.

*Multiple-effect plate evaporation plant for fructose.
Evaporation rate: 16 t/hr*

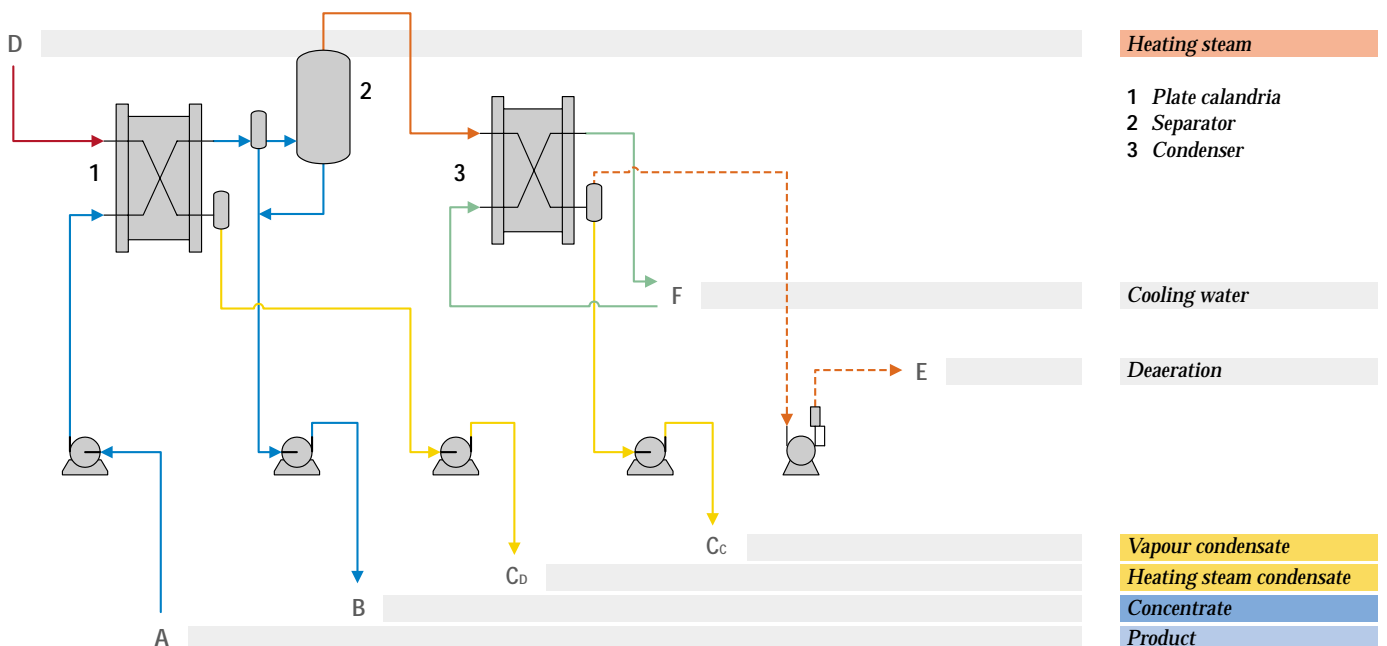

Special Evaporator Types

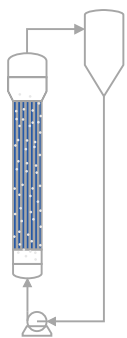

FLUIDISIED BED EVAPORATORS

Design

Vertical fluidised bed heat exchanger (on the tube side solid particles such as glass or ceramic beads, or stainless steel wire particles are entrained in the liquid), flash/vessel separator and circulation pump.

Operation

Same principle as for the forced circulation evaporator.

The upward movement of the liquid entrains the solid particles, which provide a scouring/cleaning action. Together with the liquid they are transferred through the calandria tubes.

At the head of the calandria, the particles are separated from the liquid and are recycled to the calandria inlet chamber.

The superheated liquid is flashed to boiling temperature in the downstream separator and is partially evaporated.

Particular features

- **Long operating periods** – continuous cleaning of the heating surface by the entrained beads and improved heat transfer.

Fields of application

- For products that have high fouling tendencies, where fouling cannot be sufficiently prevented or retarded in standard, forced circulation evaporators.
- For liquids of low to medium, viscosity.



FALLING FILM, SHORT PATH EVAPORATORS

Design

Vertical shell-and-tube heat exchanger equipped with concentrically arranged condenser tubes within the heating tubes and integrated separator in the lower part of the unit.

Operation

The liquid is evenly distributed over the heating tubes by means of a distribution system and flows as a thin film down the inside walls. The external heating of the tubes causes the liquid film to boil. The vapours formed are condensed as distillate on the external walls of the condensate tubes and flow downwards. Distillate and bottom product are separately kept and discharged from the lower part of the evaporator.

Particular features

- **Particularly gentle product treatment** – due to very low pressure/temperature processing, short product residence times and single pass operation. Distillation possible at vacuum pressures ranging from 1 mbar to below 0.001 mbar. Due to the integrated condenser tubes, there is no vapour flow pressure loss.
- **Optimised design** – no mechanical wear and tear, as the system has no rotating internal parts.
- **Low investment cost.**
- **Also suitable for high evaporation rates.**

Fields of application

- Particularly temperature sensitive, non-aqueous solutions.

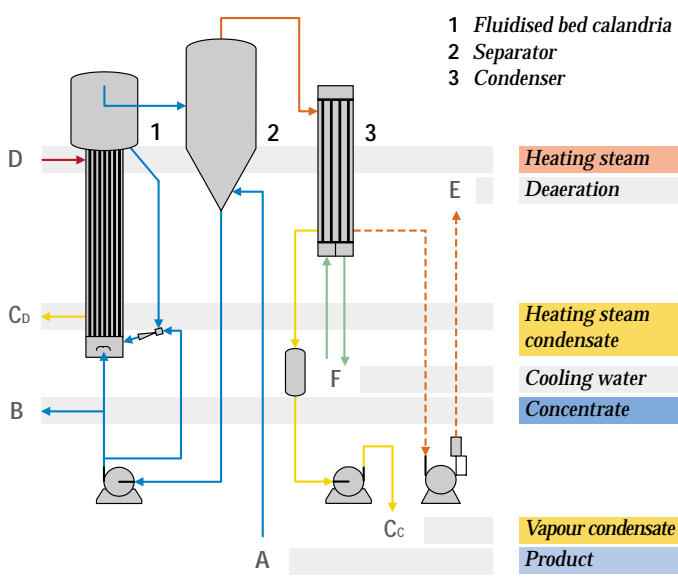

Special Evaporator Types



RISING FILM EVAPORATORS

Design

Vertical shell-and-tube heat exchanger with top-mounted vapour separator.

Operation

The liquid to be concentrated is supplied to the bottom and rises to the top in accordance with the “mammoth pump” principle, or rising film principle.

Due to external heating, the liquid film starts to boil on the inside walls of the tubes and is partially evaporated during this process. As a result of the upward movement of the steam bubbles, the liquid is transferred to the top. During the ascent more and more vapours form. The film starts to move along the wall, i.e. the liquid “rises”. The vapours and liquid are then separated in the top-mounted separator.

Particular features

- **High temperature difference between heating chamber and boiling chamber** – in order to ensure a sufficient liquid transfer in tubes of a length of 5 -7 m and to cause the film to rise.
- **High turbulence in the liquid** – due to the upward movement against gravity. For this reason, rising film evaporators are also suited for products of high viscosity and those with the tendency to foul on the heating surface.
- **Stable high-performance operation** – based on product recirculation within a wide range of conditions.

Fields of application

- For large evaporation ratios, for high viscosities and products having a tendency to foul.
- Can be used as a high concentrator in single pass operation based on extremely short residence times.



COUNTERFLOW-TRICKLE EVAPORATORS

Design

Shell-and-tube heat exchanger, lower part of calandria larger than that of e.g. the rising film evaporator; top-mounted separator equipped with integrated liquid distribution system.



Falling film counterflow trickle evaporation plant with rectification unit for olive oil refining

Operation

As in falling film evaporators, the liquid is supplied to the top of the evaporator and is distributed over the evaporator tubes, but the vapours flow to the top in counterflow to the liquid.

Particular features

- **Partial distillation** – amounts of volatile constituents contained in the product to be concentrated can be stripped. This process can be enhanced by the supply of an entraining stream, such as steam or inert gas, to the lower part of the calandria.

Fields of application

- This type of evaporator, designed for special cases, is used to enhance the mass transfer between liquid and vapour. If a gas stream is passed in counterflow to the liquid, chemical reactions can be triggered.



STIRRER EVAPORATORS

Design

External, jacket heated vessel equipped with stirrer.

Stirrer evaporator arranged as a high concentrator for yeast extract. Evaporation rate 300 kg/hr



Operation

The liquid is supplied to the vessel in batches, is caused to boil while being continuously stirred and is evaporated to the required final concentration.

If the evaporated liquid is continuously replaced by thin product, and if the liquid content is in this way kept constant, the plant can be also operated in semi-batch mode.

Particular features

- **Low evaporation rate** – due to small heat exchange surface. For this reason, large temperature differences between the heating jacket and the boiling chamber are required. The product properties permitting, the heating surface can be enlarged by means of additional immersion heating coils.

Fields of application

- For highly viscous, pasty or pulpy products, whose properties are not negatively influenced by a residence time of several hours, or if particular product properties are required by long residence times.
- It can also be used as a high concentrator downstream from a continuously operating pre-evaporator.

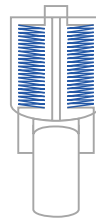

SPIRAL TUBE EVAPORATORS

Design

Heat exchanger equipped with spiral heating tubes and bottom-mounted centrifugal separator.

Operation

The liquid to be evaporated flows as a boiling film from the top to the bottom in parallel flow to the vapour. The expanding vapours produce a shear, or pushing effect on the liquid film. The curvature of the path of flow induces a secondary flow, which interferes with the movement along the tube axis. This additional turbulence considerably improves the heat transfer, especially in the case of high viscosities.

Particular features

- **Small apparatus dimensions** – due to the spiral shape, longer tube lengths and consequently larger heating surfaces relative to the overall height of the unit can be obtained.
- **Large evaporation ratios** – due to large temperature differences and single pass operation.

Fields of application

- For high concentrations and viscosities, e.g. for the concentration of gelatine.

Quantities and Concentration Ratios in Evaporation Plants

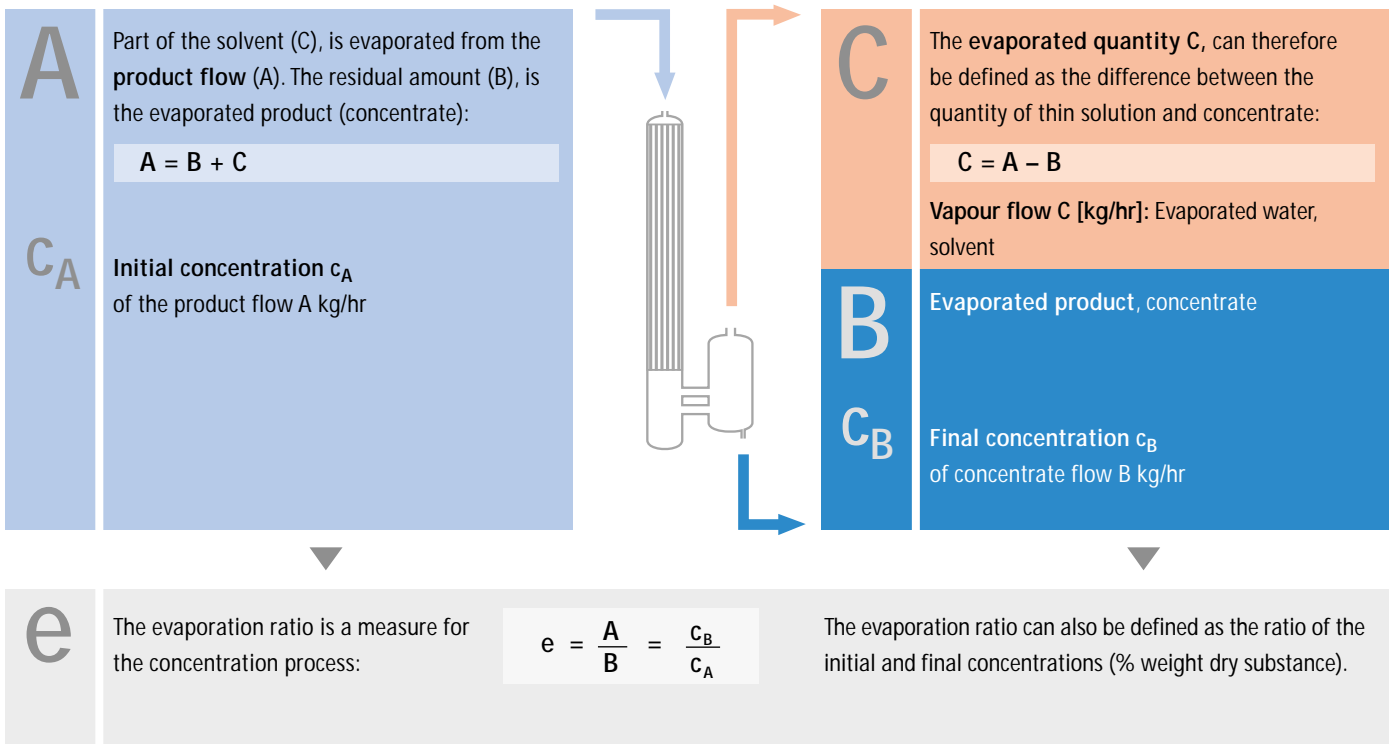

If the solvent is evaporated from thin solution A at an even rate, the concentration rises slowly at first, but rises increasingly rapidly to the theoretical maximum. At this point, no more solvent would be left in the solution. The lower the initial concentration c_A , the steeper the increase of the concentration curve. This relationship is essential for the control of evaporation plants, and in cases of high evaporation ratios, for the separation of the evaporation process into pre-evaporation and high concentration steps.

To calculate continuous evaporation processes, mass flow rates rather than volumetric quantities are used. The unit kg/hr is used for A, B and C. The ratios indicated above do not change.

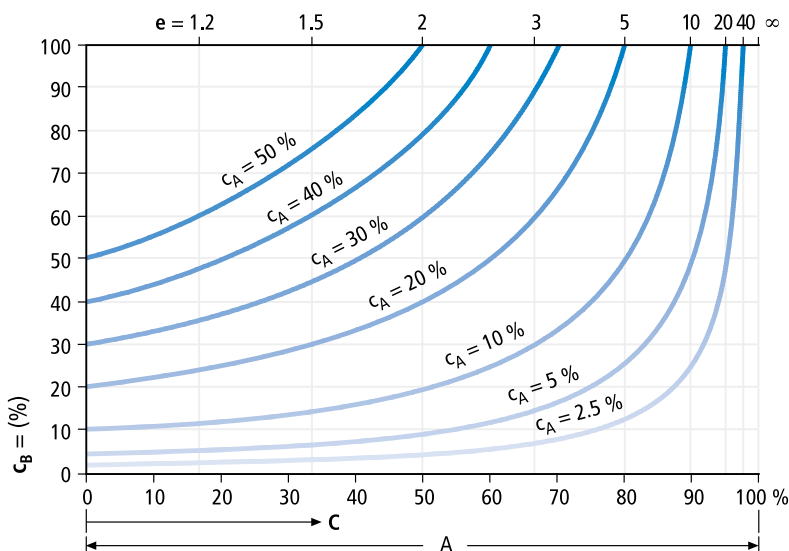

If the concentrations or the evaporation ratio is known, the quantities can be calculated using the formulae in the table below:

Given	Required	Formula
Quantity A to be evaporated	C	$C = A \cdot \frac{e - 1}{e}$
	B	$B = A \cdot \frac{1}{e}$

Left: Increase of final concentration during the evaporation from solutions at different initial concentrations

Energy Efficiency of Evaporation Plants

The operating costs of an evaporation plant are largely determined by the energy consumption.

Under steady-state conditions there must be a balance between the energy entering and leaving the system.

The energy consumption of the system can be tailored to meet the customer's individual requirements by intelligent thermal configurations of the evaporation plant.

There are three basic possibilities to save energy:

- Multiple-effect evaporation
- Thermal vapour recompression
- Mechanical vapour recompression

Application of one of these techniques will considerably decrease the energy consumption. Often it is feasible to combine two of these possibilities to minimise capital and operating costs. In highly sophisticated evaporation plants all three techniques may be applied.

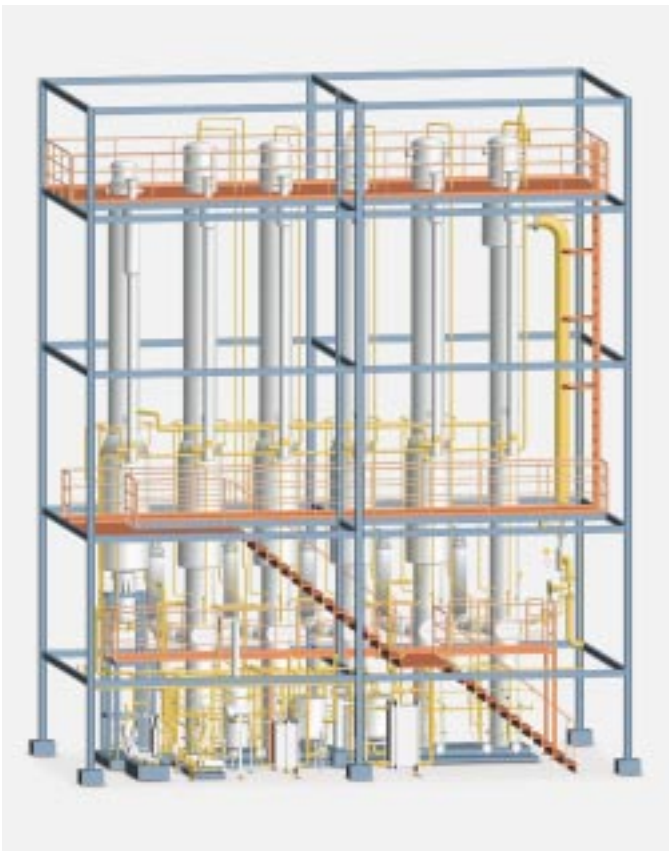

5-effect falling film evaporation plant for apple juice concentrate, directly heated, with aroma recovery. Evaporation rate: 12,000 kg/hr

Multiple-effect evaporation

If we consider the heat balance of a single-effect evaporator we find that the heat content (enthalpy) of the evaporated vapour is approximately equal to the heat input on the heating side. In the common case of water evaporation, about 1 kg/hr of vapour will be produced by 1 kg/hr of live steam, as the specific evaporation heat values on the heating and product sides are about the same.

If the amount of vapour produced by primary energy is used as heating steam in a second effect, the energy consumption of the overall system is reduced by about 50 %. This principle can be continued over further effects to save even more energy.

	Live steam	Vapour	Specif. steam consumption
1-effect-plant	1 kg/h	1 kg/h	100 %
3-effect-plant	1 kg/h	3 kg/h	33 %

The maximum allowable heating temperature of the first effect and the lowest boiling temperature of the final effect form an overall temperature difference which can be divided among the individual effects. Consequently, the temperature difference per effect decreases with an increasing number of effects. For this reason, the heating surfaces of the individual effects must be dimensioned accordingly larger to achieve the required evaporation rate, but with a lower temperature difference (Δt). A first approximation shows that the total heating surface of all effects increases proportionally to the number of effects. Consequently, the investment costs rise considerably whereas the amount of energy saved becomes increasingly lower.

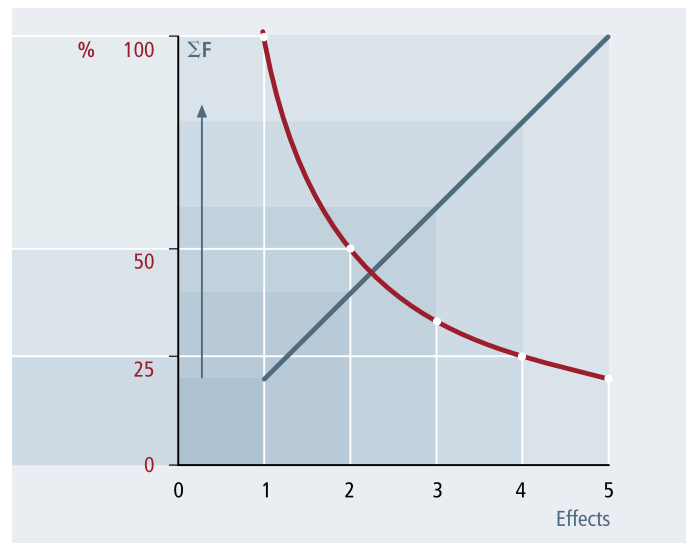

Decrease of the specific steam consumption in % and increase of the approximate total heating surface ΣF in relation to the number of effects

Energy Efficiency of Evaporation Plants

Thermal vapour recompression

During thermal vapour recompression, vapour from a boiling chamber is recompressed to the higher pressure of a heating chamber in accordance with the heat pump principle. The saturated steam temperature corresponding to the heating chamber pressure is higher so that the vapour can be reused for heating.

To this end, steam jet vapour recompressors are used. They operate according to the steam jet pump principle. They have no moving parts and are therefore not subject to wear and tear. This ensures maximum operational reliability.

The use of a thermal vapour recompressor gives the same steam/energy saving as an additional evaporation effect.

A certain steam quantity, the so-called motive steam, is required for operation of a thermal vapour recompressor. This motive steam portion is transferred as excess vapour to the next effect or to the condenser. The energy of the excess vapours approximates the energy of the motive steam quantity used.



3-effect falling film forced circulation evaporation plant heated by thermal vapour recompressor for waste water from sodium glutamate production. Evaporation rate: 50 t/hr

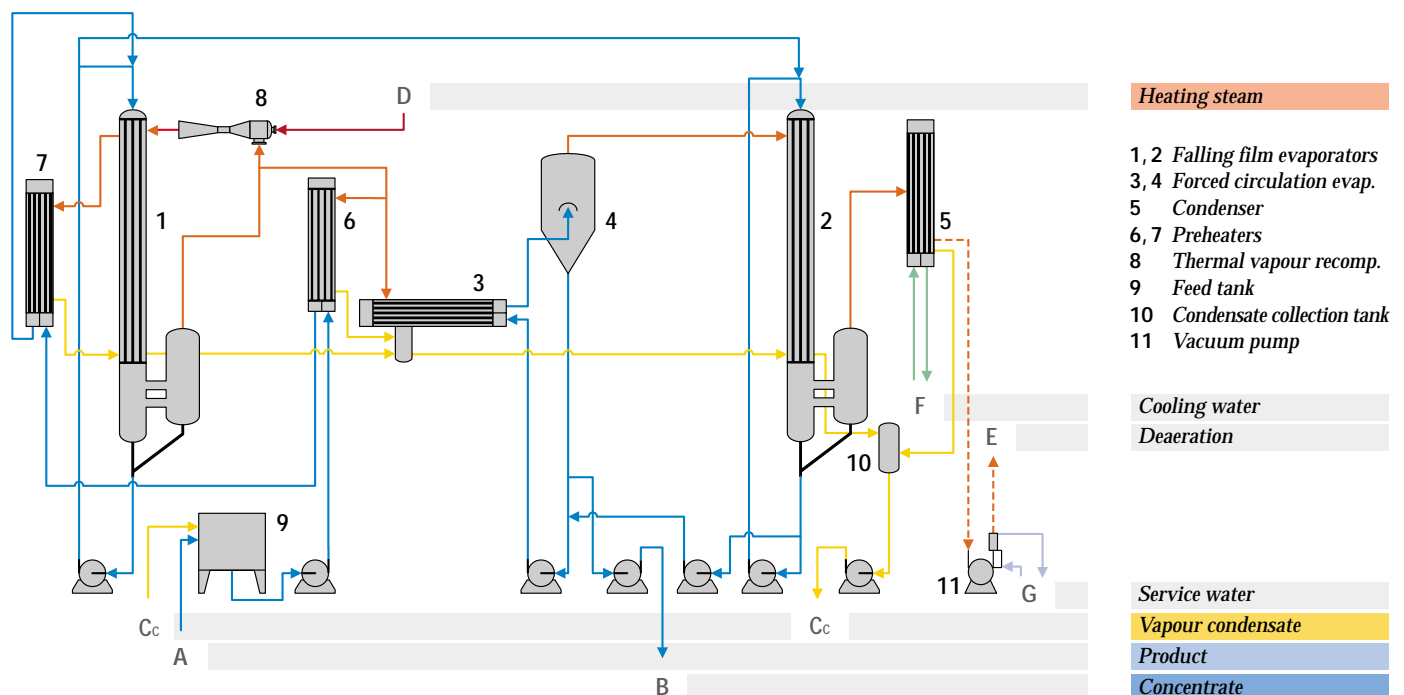

Mechanical vapour recompression

Evaporation plants heated by mechanical vapour recompressors require particularly low amounts of energy.

Whereas steam jet compressors only compress part of the vapour, mechanical vapour recompressors recycle all of the vapour leaving the evaporator. The vapour is recompressed to the pressure of the corresponding heating steam temperature of the evaporator, using a mere fraction of electrical energy relative to the enthalpy recovered in the vapour. The operating principle is similar to that of a heat pump. The energy of the vapour condensate is frequently utilized for the preheating of the product feed. The amounts of heat to be dissipated are considerably reduced, with the evaporator itself re-utilizing the energy normally dissipated through the condenser cooling water. Depending on the operating conditions of the plant, a small quantity of additional steam, or the condensation of a small quantity of excess vapour may be required to maintain the overall evaporator heat balance and to ensure stable operating conditions.

Due to their simplicity and maintenance friendly design, single stage centrifugal fans are used in evaporation plants. These

units are supplied as high pressure fans or turbo-compressors. They operate at high flow velocities and are therefore suited for large and very large flow rates at vapour compression ratios of 1:1.2 to 1:2. Rational speeds typically are 3,000 up to 18,000 rpm. For high pressure increases, multiple-stage compressors can be used.

(See our special brochure "Evaporation Technology using Mechanical Vapour Recompression").



1-effect falling film evaporation plant heated by mechanical vapour recompression for wheat starch effluent. Evaporation rate: 17,000 kg/hr

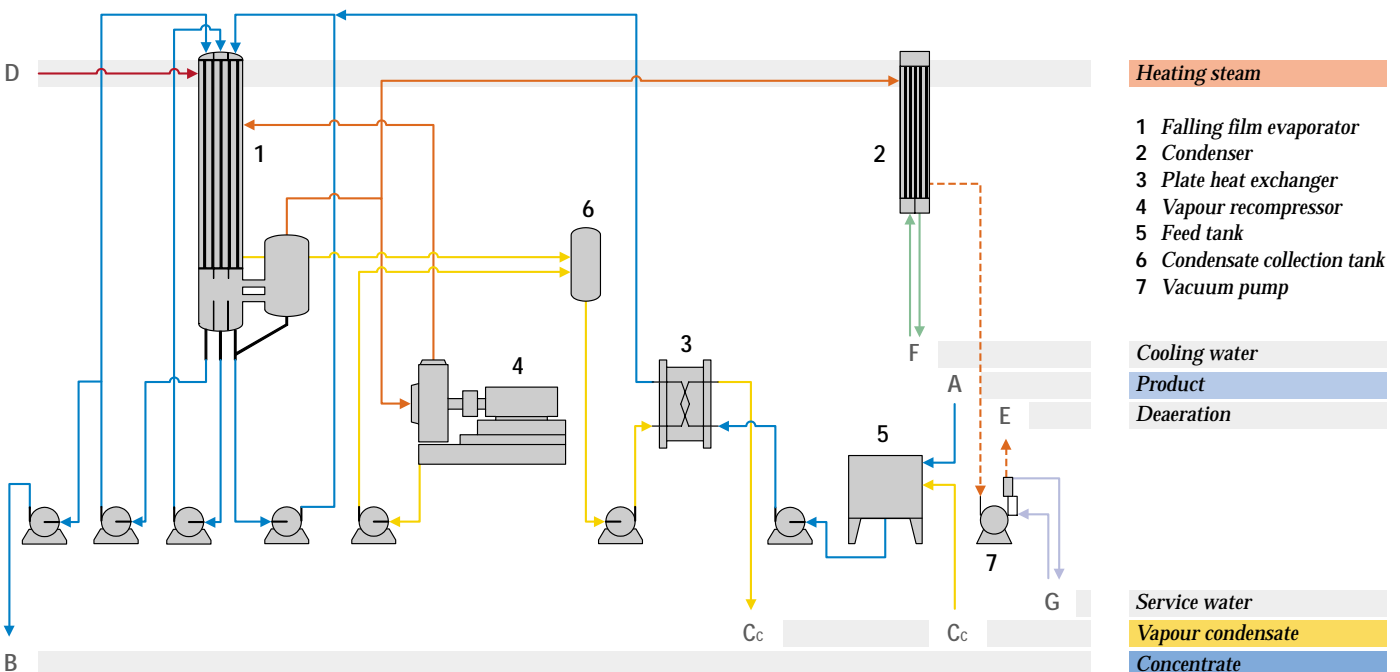

Energy Efficiency of Evaporation Plants

Mass/energy flow diagrams of an evaporator with different types of heating

Directly heated

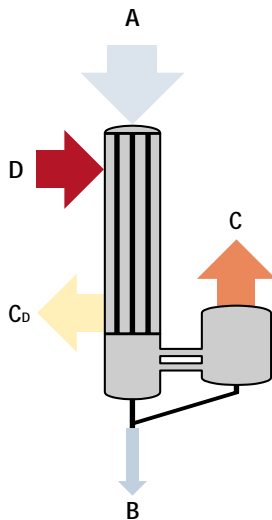

If we consider the heat balance of a single-effect evaporator we find that the heat content (enthalpy) of the evaporated vapour (C) is approximately equal to the heat input (D) on the heating side. In the common case of water evaporation, about 1 kg/hr of vapour will be produced by 1 kg/hr of live steam, as the specific evaporation heat values on the heating and product sides are about the same.

Thermal vapour recompression

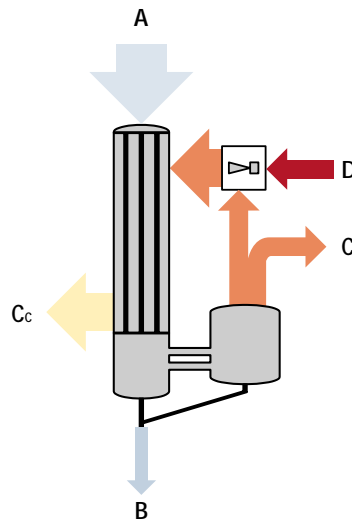

A certain quantity of live steam, the so-called motive steam, is required for the operation of a thermal vapour recompressor. This motive steam quantity must be transferred to the next effect or to the condenser as surplus residual vapour. The surplus energy contained in the residual vapour approximately corresponds to the amount of energy supplied in the motive steam.

Mechanical vapour recompression

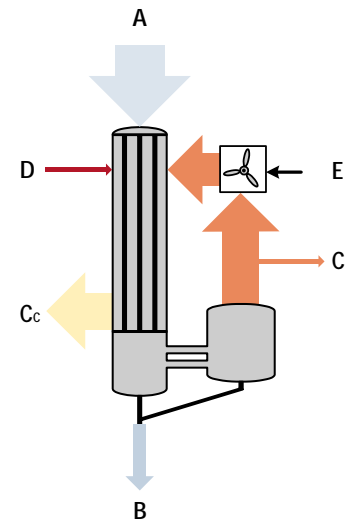

The operation of evaporation plants heated by mechanical vapour recompressors requires a particularly low amount of energy. The operating principle of a mechanical vapour recompressor is similar to that of a heat pump. Almost the entire vapour quantity is compressed and recycled by means of electrical energy. Only minimum quantities of live steam are required, generally just during start-up. The quantities of residual "waste" heat to be dissipated are considerably reduced.

2-effect design

If the amount of vapour produced by primary energy is used as heating steam in a second effect, the energy consumption of the overall system is reduced by about 50 %. This principle is repeated over further effects to save even more energy.

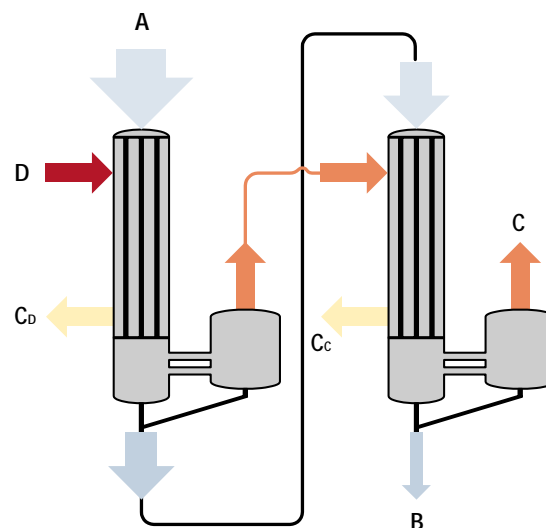

- A Product
- B Concentrate
- C Condensate
- Cc Vapour condensate
- Co Heating steam condensate
- D Heating steam
- E Electrical energy

Criteria for the Design Selection, Arrangement and Operating Modes of Evaporation Plants

When designing evaporation plants, various and often contradictory requirements must be taken into consideration. These determine the type of design, arrangement and the resulting process and cost data.

GEA Wiegand evaporation plants are characterised by their high quality, efficiency and design refinements. Careful attention is paid to the above mentioned criteria in view of the individual requirements. In addition, a strong emphasis is placed on reliability and ease of operation.

The most important requirements are as follows:

- Capacity and operating data such as quantities, concentrations, temperatures, annual operating hours, change of product, control, automation.
- Product properties such as temperature sensitivity, viscosity and flow properties, tendency to foaming, fouling and precipitation, boiling properties.
- Utility Requirements such as steam, cooling water, electricity, cleaning agents, parts exposed to wear and tear.
- Selection of materials and surface finish.
- Capital costs for interest and repayments.
- Personnel costs for operation and maintenance.
- Site conditions such as space availability, climate for outdoor installations, connections for energy and product, service platforms.
- Legislative framework regarding health and safety, prevention of accidents, sound propagation, environmental protection and others, depending on the specific project.

Evaporation Plant Components

The core of any evaporation plant is the calandria. For the operation of the plant, several additional components are required.

The most important of these are condensers, preheaters, pumps, fittings, vents, vacuum systems and cleaning systems.

If substances are to be separated, the plants are also equipped with rectification columns, membrane filtration units, scrubbing and aroma recovery systems.

To guarantee trouble-free operation of the plant, state-of-the-art measuring, control and computer monitoring systems are used.

Attention to detail, safety and protective equipment and thermal and sound insulation ensure safe operation of the plant.

GEA Wiegand designs, builds and supplies turnkey evaporation plants. Our experience and expert knowledge of the performance of each individual component enables us to select the right equipment for each application so that the requirements of the entire evaporation plant will be met.

Evaporation Plant Components

Preheaters and heaters

In most cases the product to be evaporated must be preheated to boiling temperature before it enters the calandria. As a rule straight tube preheaters or plate heat exchangers are used for this duty.

Evaporators

The selection of the suitable type of evaporator is dependent on the particular case of each application and the product properties.

Separators

Each evaporator is equipped with a unit for separating vapours from liquids. Depending on the field of application different types of separators are chosen, e.g. centrifugal separators, gravitational separators or separators equipped with internals. Essential design criteria are separating efficiency, pressure loss and frequency of cleaning.

Condensers

Where possible, the heat content of the vapours produced during evaporation is used for heating downstream effects and preheaters, or the vapours are recompressed and re-utilized as the heating medium. The residual vapours from the last effect of an evaporation plant which cannot be used in this way must be condensed. Evaporation plants can be equipped with surface, contact or air-cooled condensers.

Deaeration/vacuum systems

Vacuum pumps are required for maintaining the vacuum in the evaporation plant. They discharge leakage air and non-condensing gases from the process, including dissolved gases which are introduced in the liquid feed. For this application, jet pumps and liquid ring pumps can be used depending on the size and the operating mode of the evaporation plant.

Pumps

Pumps must be chosen in view of a wide range of design conditions and applications. The main criteria for the selection of pumps are product properties, suction head conditions, flow-rates and the pressure ratios in the evaporation plant.

For low-viscosity products, centrifugal pumps are mostly used. Highly-viscous products require the use of positive displacement pumps. For liquids containing solids or crystallised products, other pump types such as propeller pumps are used. The type, size, speed, mechanical seals and material are determined by the particular case of application and the relevant conditions of use.

Cleaning systems

Depending on the product, scaling and fouling might occur after a certain operating time. Scale and fouling deposits can be removed by chemical cleaning in most cases. To this end, the evaporation plant is equipped with the necessary components, cleaning agent tanks, additional pumps and fittings. This equipment, ensuring ease of cleaning without disassembly, is commonly referred to as "Cleaning in Place" or CIP. Cleaning agents are chosen according to the type of deposit. The cleaning agents penetrate the incrustation, dissolve or disintegrate it and completely clean and, where necessary, sterilise the evaporator surfaces.

Vapour scrubbers

A vapour scrubber is required where the plant is not heated with live steam but with discharge stream such as dryer exhaust vapours. The vapours must be cleaned before they are transferred into the heating chamber of the evaporation plant in order to avoid contamination and fouling.

Condensate polishing systems

In spite of optimised droplet separation, the condensate quality might not correspond to the required purity especially if the product contains volatile constituents. Depending on the case of application the condensate can be further purified by means of a rectification column or a membrane filtration system.

Materials

The materials of the evaporation plant are determined by the requirements of the product and the customer's request. Depending on the corrosion behaviour under the relevant design conditions, a wide variety of materials is used. Stainless steels are most commonly used. For special requirements, Hastelloy, titanium, nickel, copper, graphite, rubberised steel or synthetic materials can also be used. As required the design and manufacture will comply with international standard directives and codes.

*Depiction of a 4-effect evaporation plant for corn stillage, consisting of a 3-effect falling film evaporator and a single-effect forced circulation evaporator. The plant is directly heated with dryer exhaust vapours. The vapours are cleaned in a vapour scrubber.
Evaporation rate: 130 t/hr*

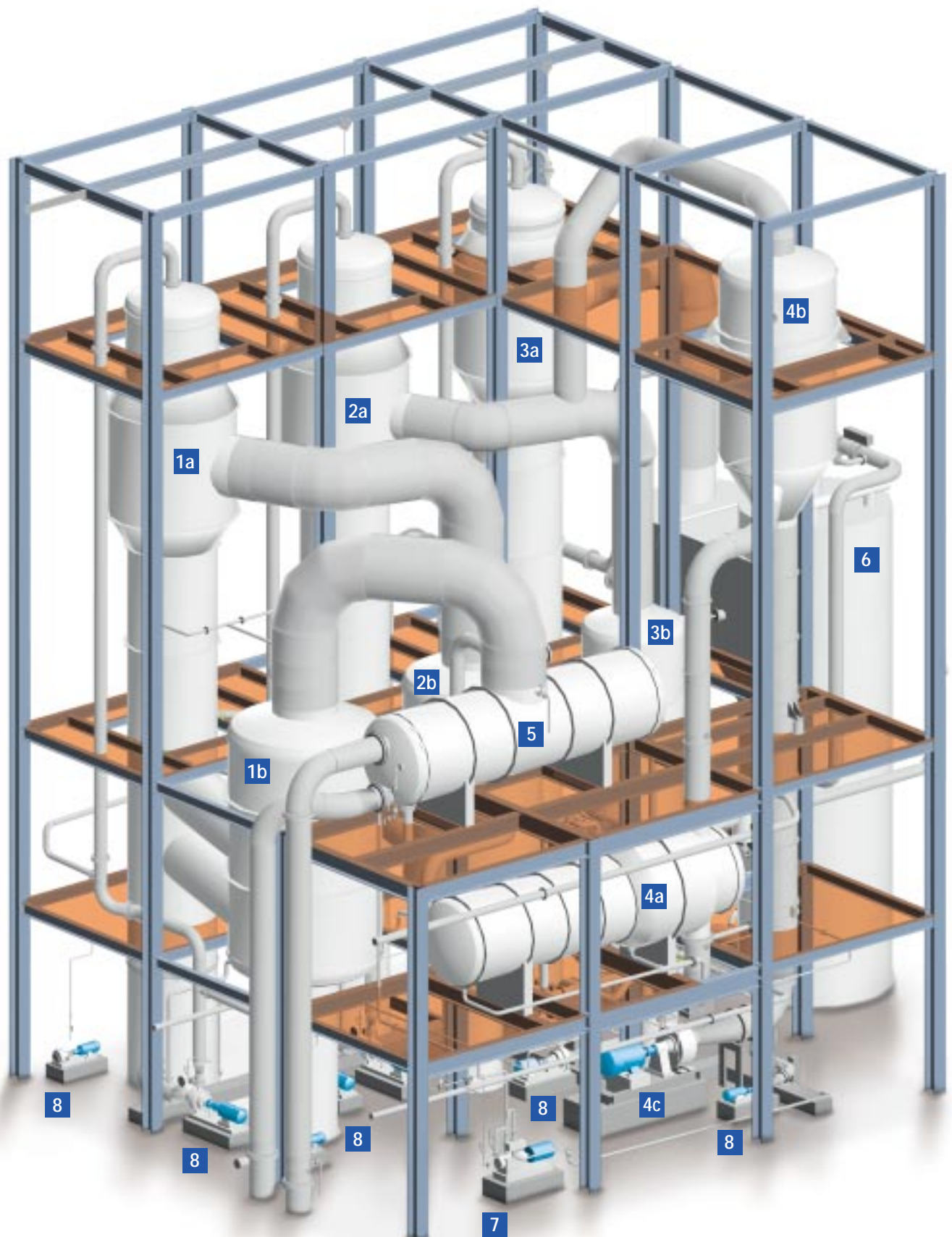

- | | | | |
|----------|--|---|------------------------------|
| 1a, b | Falling film evaporator with centrifugal separator | 5 | Surface condenser |
| 2a, b | Falling film evaporator with centrifugal separator | 6 | Vapour scrubber |
| 3a, b | Falling film evaporator with centrifugal separator | 7 | Vacuum pump |
| 4a, b, c | Forced circulation evaporator with flash vessel/
gravitational separator and circulation pump | 8 | Product and condensate pumps |

Measuring and Control Equipment

The major goal of the evaporation process is to achieve a constant final concentration of the product. It is therefore important to maintain all parameters, such as steam pressure, product feed and vacuum, which might influence the evaporation plant or alter the mass and heat balances.

In accordance with the technical and customer's requirements, GEA Wiegand evaporation plants are equipped with the relevant measuring and control systems. We supply conventional control systems as well as process control systems.

1. Manual control

The plant is operated by means of manually operated valves. Concentrate samples must be checked at certain intervals. This type of control is suitable for simple plants and for products where slight variations in quality are acceptable.

2. Semi-automated control system

The most important parameters such as steam pressure, product feed quantity, vacuum, final concentrate density and liquid level are kept constant by means of hardware controllers and are recorded by a data recorder. Pump motors and valves are manually operated from a control panel.

3. Semi-automated control system based on PLC control

The plant is operated by means of software controllers from a programmable logic controller (PLC) with operating inputs and a data monitoring system provided by a PC. The controllers, motors and valves are manually operated from the PC. Smaller program sequences such as "cleaning mode" are possible. All key measured values are recorded and displayed on the monitor. Control and operating systems are chosen on the basis of GEA Wiegand specifications or customer specifications.

4. Automated control system based on PLC control

As an extended version, the PLC system is used as automation system for the program sequences of "start-up", "switch-over to product", "production", "cleaning" and "shut-down".



The processes can be centrally operated and monitored on the screen by means of a bus system. Set points and other key parameters are entered into the fields shown on a graphic display. The plant is self-monitored and is automatically switched to a safe mode in the event of operating trouble. The use of a multiple operator station system increases the availability.

5. Process control system

The plant is controlled by one or several automation systems, which can also be integrated into existing process structures. The process control system is particularly suited for multiple product and batch processes.

Manufacture, Transport, Erection, Commissioning and After-sales Service



The GEA Wiegand manufacturing workshop is situated in Beckum, Westphalia. Covering an area of more than 6,500 m², large parts of our plants are manufactured and prepared for transport.

In some cases small plants are completely assembled at the manufacturing workshop and are dispatched as compact or skid mounted units, ready for site connection. Most plants, however, are assembled on site due to their size.

Depending on the arrangement evaporation plants can be extremely complex, and therefore the first commissioning requires certain experience. Experienced specialists are therefore assigned to this task, who are also available to train the customer's personnel.

Each plant permanently achieves its optimal performance if it is expertly maintained. This service requires specialists who, if required, immediately trace and eliminate faults so that production losses caused by periods of standstill can be minimised. Our trained service personnel are therefore available to you. Thanks to their up-to-date training they are in a position to carry out maintenance and repairs quickly and thoroughly. Users benefit from our spare parts service, based on our plant reference numbers and a description of the item, spares can be ordered online or quotations requested for the required parts.

Our Range of Products in Summary

Evaporation plants

for the concentration of all types of liquid food, organic and inorganic solutions, waste water and other types of liquid products by means of thermal or mechanical vapour recompressors, single-effect or multi-effect systems, with additional equipment for heating, cooling, degassing, crystallization, rectification etc.

Membrane filtration

for the concentration of liquid food, process water, organic and inorganic solutions and waste water, for the separation of impurities for upgrading and valuable material recovery; based on technology and references by GEA Filtration, Hudson, USA.

Distillation/rectification plants

for the separation of multi-component mixtures, e.g. for the recovery of organic solvents, the recovery, purification and dehydration of bioalcohol of different qualities.

Lines for the production of alcohol

from the treatment of raw material, fermentation and distillation to stillage concentration and drying of spent products.

Plants for crystallization

of special products as well as waste water containing salts.

Product studies, engineering

for plants included in our range of products.

